

Arteor™

with NETATMO

SMART HOME MADE EASY

Contents

02

Installation components

08

Installation tips

10

Example scenarios

12

Wiring diagrams

14

Setup
and pairing

16

Home + Control app

24

Catalogue pages

29

Compatibility

Arteor™

with NETATMO

SMART HOME MADE EASY



INSTALLATION COMPONENTS

A smart home installation consists of wired products, which can be installed as new or retrofitted as a replacement for existing switches and powerpoints. Wireless switches can then be paired with wired products as shown in this table.

WIRED PRODUCTS

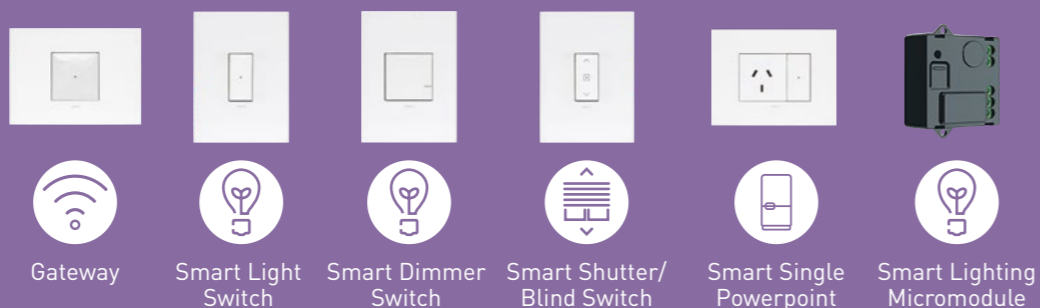

WIRELESS SWITCHES

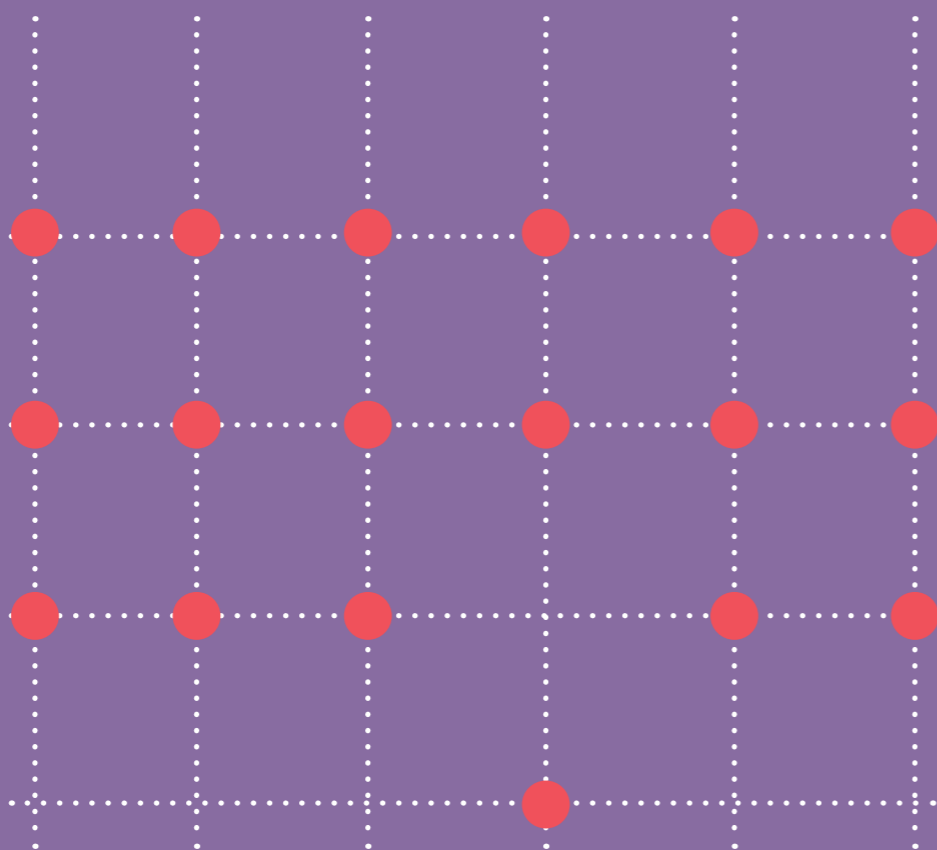
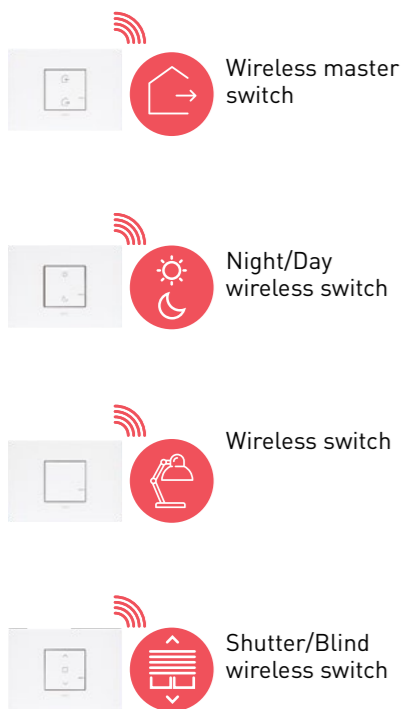

All the products communicate by means of Zigbee radio (2.4 GHz waveband). **Advantage: a dynamic mesh network!**

1

START THE INSTALLATION



ARTEOR WITH NETATMO STARTER KIT

- 1 Smart Light Switch
- 1 Smart Single Powerpoint
- 1 Wireless Master Switch
- 1 Gateway

2

EXTEND THE INSTALLATION

EXTENSION KIT



ARTEOR WITH NETATMO EXTENSION KIT

- 1 Smart Dimmer Switch
- 1 Smart Single Powerpoint
- 1 Wireless Switch

AND/OR

SMART WIRED PRODUCTS



+

WIRELESS SWITCHES



INSTALLATION COMPONENTS



CONNECTED GATEWAY

Install the gateway **close to an internet router** to optimise the Wi-Fi signal reception. The gateway then communicates with individual switches and sockets using Zigbee radio.

Just one gateway is needed per dwelling. It can control up to **100 wired and wireless products**.

Can **replace an existing power outlet**: same wiring, same mounting centres.

The gateway is sold in the starter kit or basic kit and cannot be sold separately.

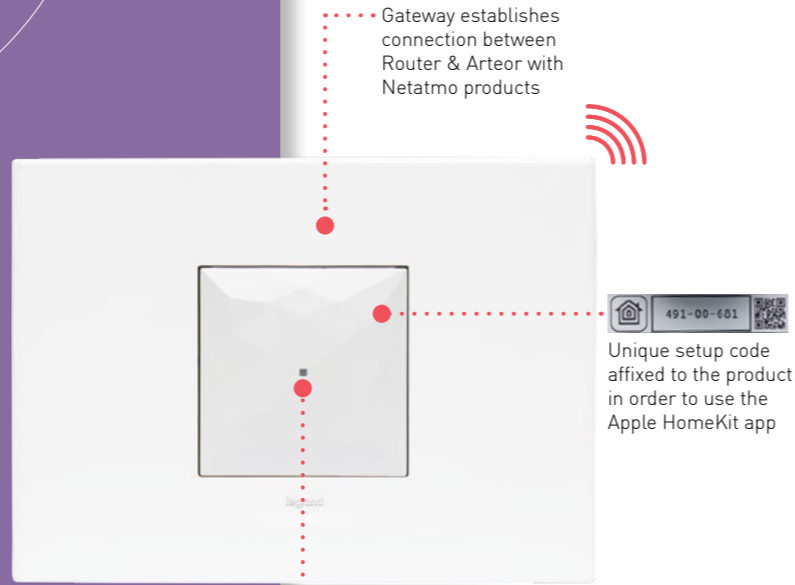

WIRELESS MASTER SWITCH

Extra-slim, attached to the wall with the adhesive strips provided. It can be repositioned.

Is installed **near the entrance door** to control Home/Away scenarios involving lights, shutters and power outlets.

Sold both in the starter kit and individually, to be added if the house has more than one entrance. Customised scenarios should be identical on all the master switches.

Scenarios should be configured in the Home + Control app.

CR 2032 - 3V button battery supplied
Standby power: 8 years

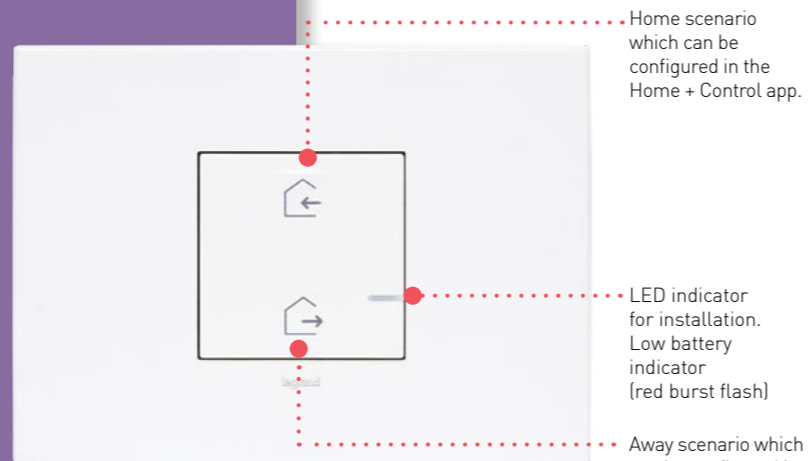

STARTER KIT



SMART LIGHT SWITCH

Can replace an existing switch, with the same wiring and mounting centres.

Controls all types of conventional and dimmable bulbs, from 5W to 300W: LED, halogen, and compact fluorescent.

Supplied with a load stabilising capacitor, which should be wired up as close as possible to the load. This limits flickering during operation.



SMART DIMMER SWITCH

Can **replace an existing switch**: same wiring, same mounting centres. No need for neutral (N) wire.

Controls all types of conventional and dimmable bulbs, from **5 to 300 W**: LED, halogen, compact fluorescent.

Always use **dimmable LEDs**.

The dimmer option can be activated from the Home + Control app.

Supplied with a **load stabilising capacitor** which should be wired up as close as possible to a lamp. This is vital to ensure smooth lighting operation, especially for dimming, whatever the type of bulb connected.



SMART LIGHTING MICROMODULE

To be installed near or **directly on the light source**. Used to provide connected lighting.

Controlled by one or more wireless switches and/or conventional pushbuttons when replacing a remote switch.

For all types of bulbs **up to 300 W**: LED, halogen, compact fluorescent.

WIRED PRODUCTS

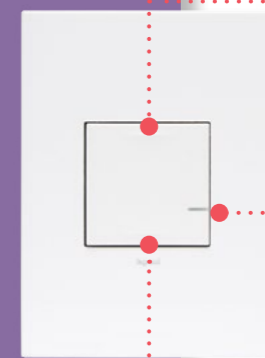
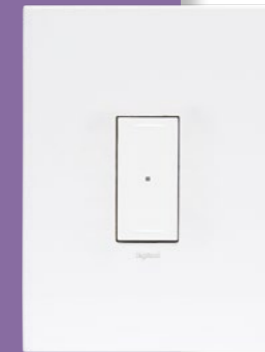

Switch-off: quick press.
Dimming: press & hold

Optional illuminated switch: LED can be activated from the Home + Control app

100% lighting: quick press.
Dimming: press & hold

Load stabilising capacitor to ensure optimum operation of dimmable lamps. Only one load stabilising capacitor is sufficient for all the lamps on the switched lighting circuit

LED indicator for installation

Dimensions (with fixing lugs): 52x40x20mm

INSTALLATION COMPONENTS



SMART SHUTTER/BLIND SWITCH

Can **replace an existing switch**: same wiring, same mounting centres.
Compatible with **all wired shutter motors** with electronic or mechanical end stop.

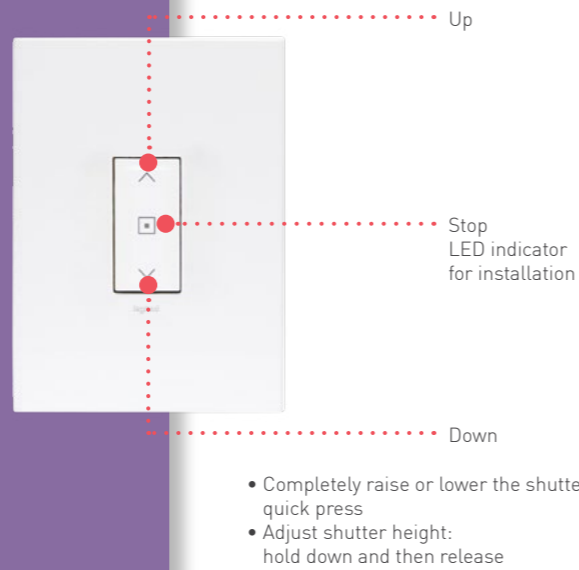

SMART SINGLE POWERPOINT - 10A

Can **replace an existing powerpoint**: same wiring, same mounting centres.
The Smart Powerpoint can measure the instantaneous and total power consumption. It is compatible with all electrical appliances, especially with large household appliances.
Extra built-in protection in case of overloads of more than 10A.

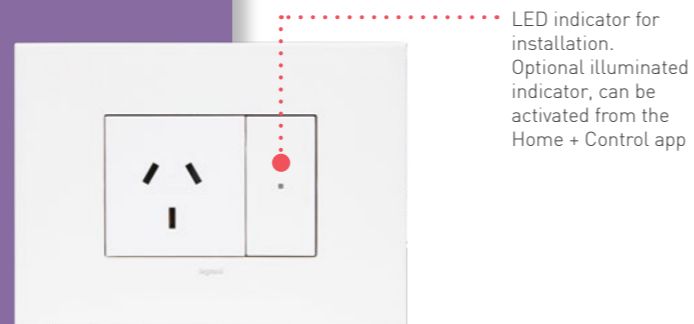

WIRED PRODUCTS



NIGHT/DAY WIRELESS SWITCH

Extra-slim, attached to the wall with the adhesive strips provided. It can be repositioned.
Used to **create scenarios** involving lights, shutters and powerpoints at the time people wake up and go to sleep.
Scenarios should be configured in the Home + Control app.
CR 2032 - 3V button battery supplied.
Standby power: 8 years

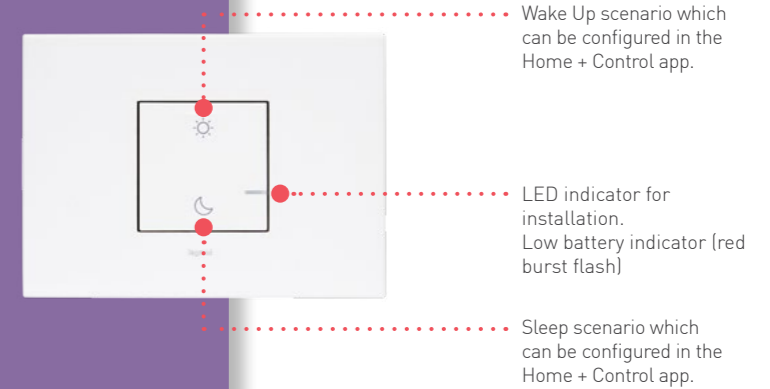

WIRELESS SWITCH

Extra-slim, attached to the wall with the adhesive strips provided. It can be repositioned.
Controls smart light or dimmer switches, micromodules and smart powerpoints.
CR 2032 - 3V button battery supplied.
Standby power: 8 years

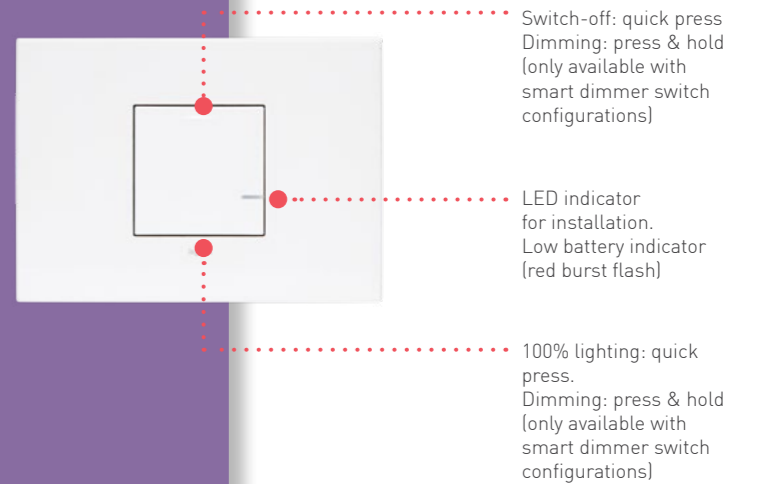

WIRELESS SHUTTER/BLIND SWITCH

Extra-slim, attached to the wall with the adhesive strips provided. It can be repositioned.
Controls smart shutter/blind switches and can **centralise** control of several shutters.
CR 2032 - 3V button battery supplied.
Standby power: 8 years

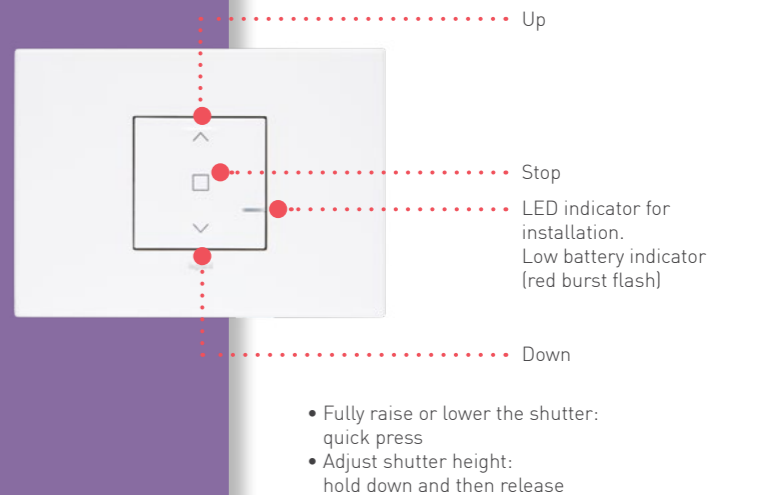

CREATE A TWO-WAY SWITCH FOR NEW OR RETROFIT INSTALLS

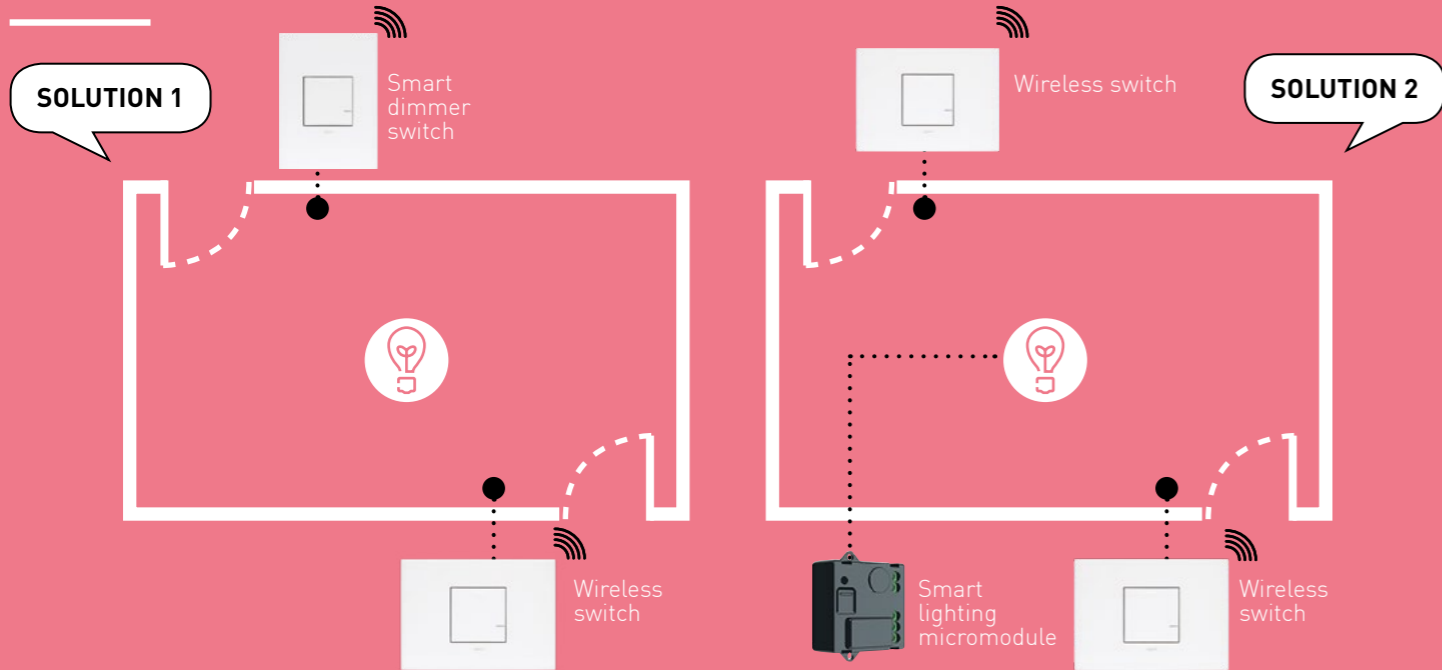

CREATE SEVERAL CONNECTED CONTROL POINTS

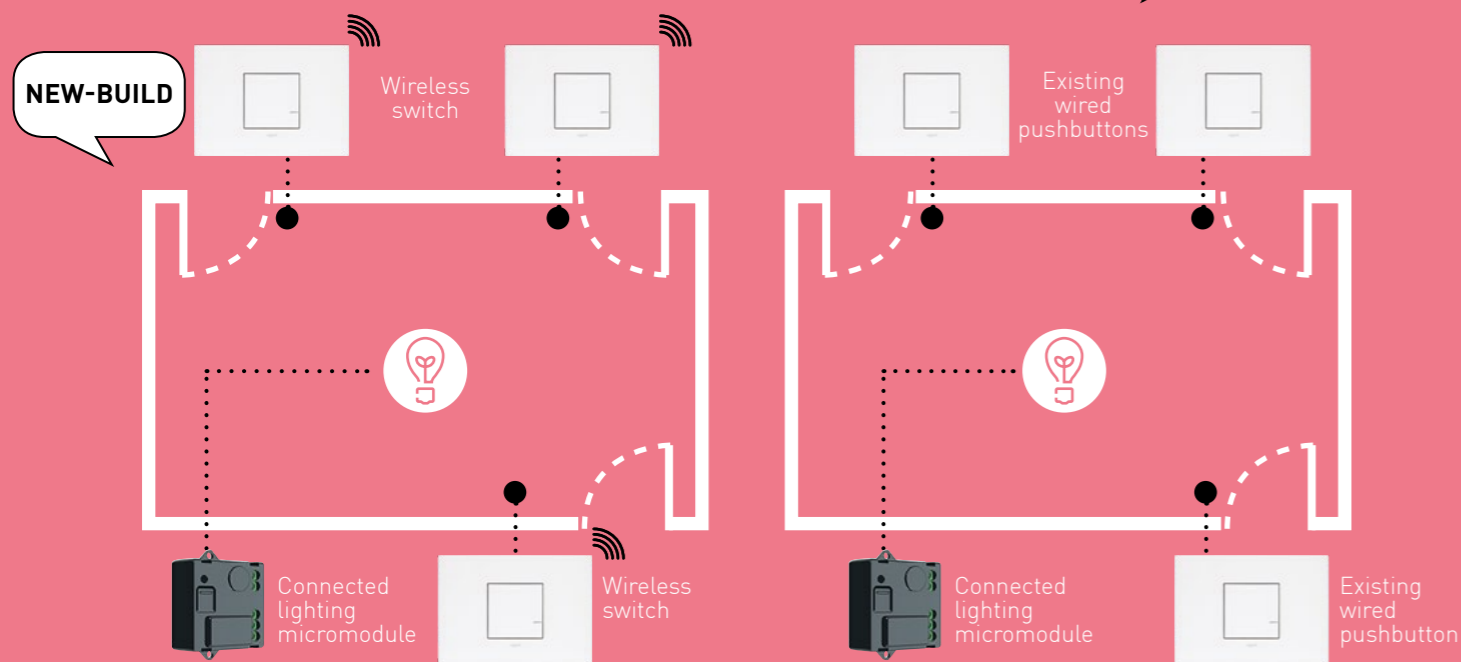

CREATE A SWITCHED POWER OUTLET FOR NEW OR RETROFIT WORK

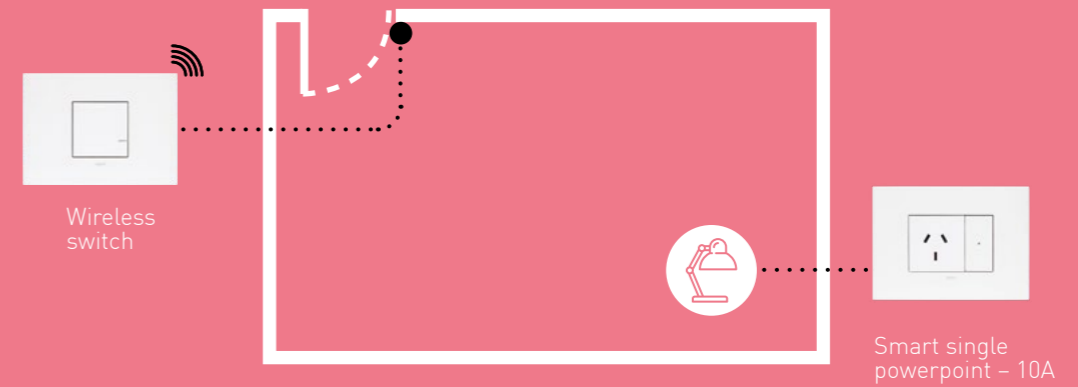

CENTRALISE SHUTTER/BLIND CONTROL

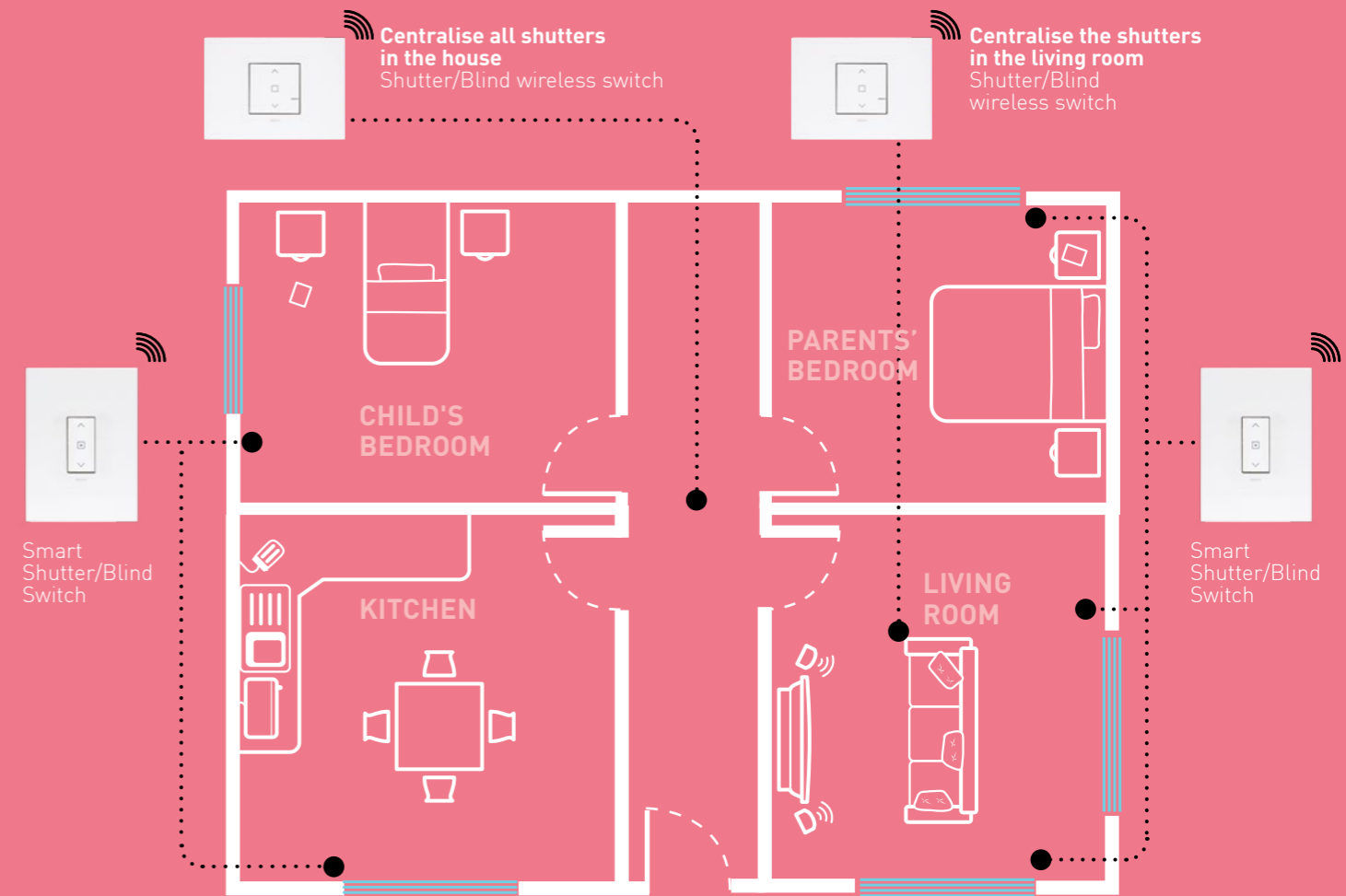

EXAMPLE SCENARIOS

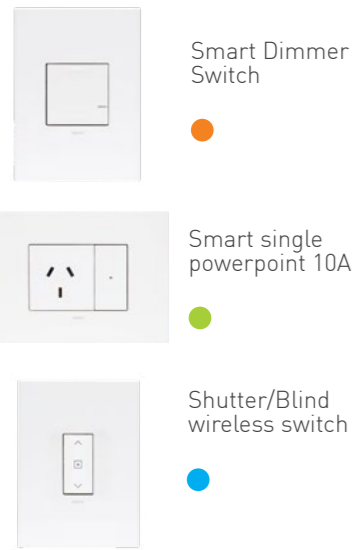

Below are some examples of scenarios which can be created in the Home + Control app and activated with a single touch. The installed wired products control lights, lamps, electrical appliances and shutters/blinds.

“LEAVE” SCENARIO

Wireless master switch located by the entrance door. Pressing the **bottom of the button** activates the scenario, which can be customised to suit users' needs in the Home + Control app.



- Switches off all ceiling and wall lights
- Switches off all lamps and standard lamps
- Closes the shutters in the living room

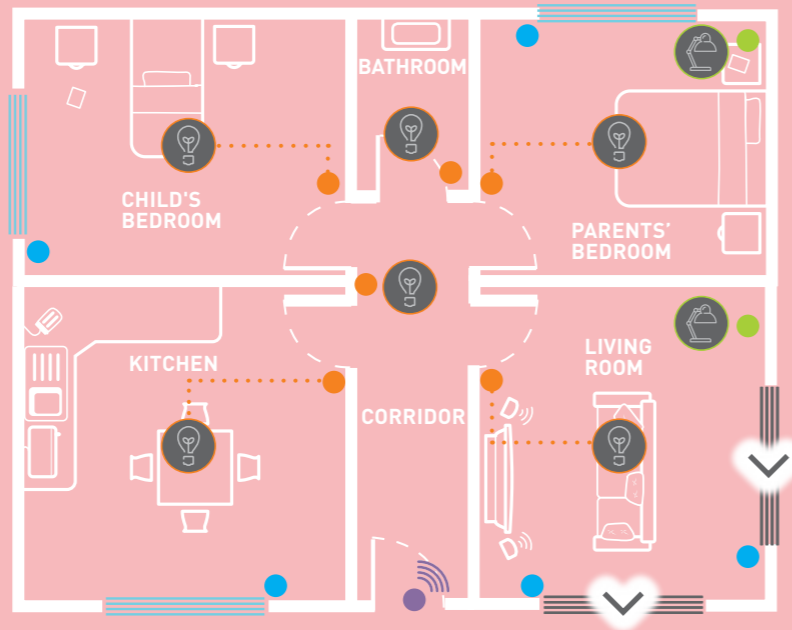

“SLEEP” SCENARIO

Night/Day wireless switch located in the parents' bedroom. Pressing the **bottom of the button** activates the scenario, which can be customised to suit users' needs in the Home + Control app.



- Switches off all ceiling and wall lights
- Switches off all lamps and standard lamps
- Switches on the lights in the parents' bedroom
- Closes all the shutters

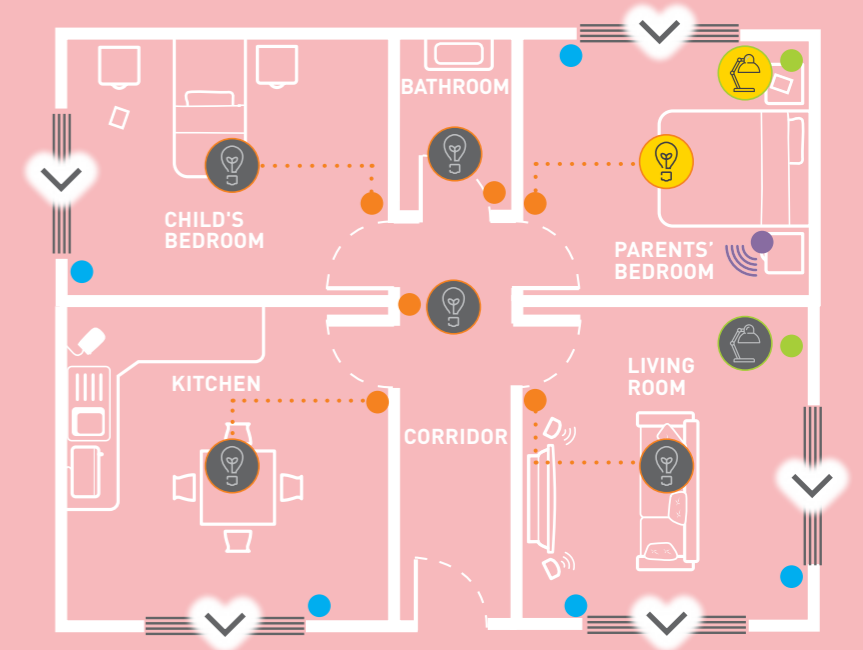

“ARRIVE” SCENARIO

Wireless master switch located by the entrance door. Pressing the **top of the button** activates the scenario, which can be customised to suit users' needs in the Home + Control app.

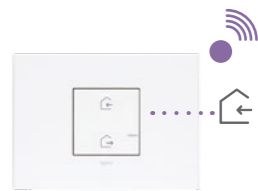

- Switches on the lights in the corridor
- Switches on the lights and standard lamp in the living room

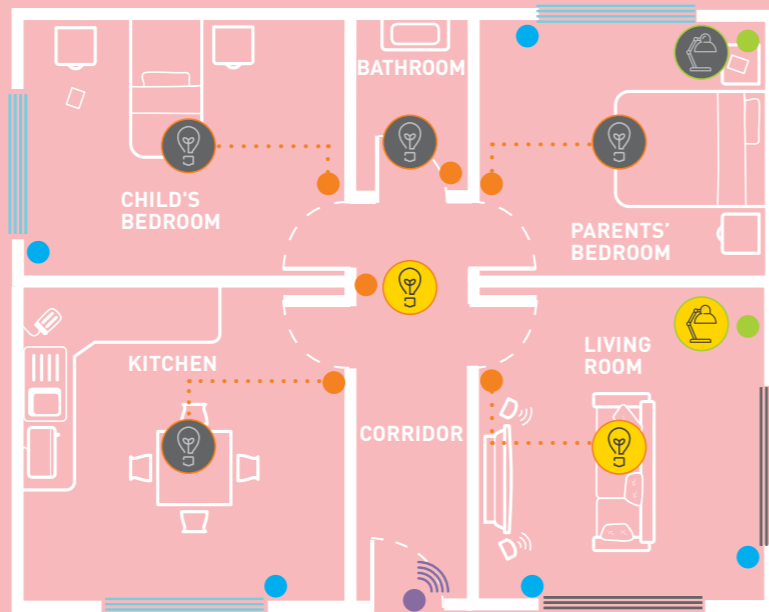

“WAKE UP” SCENARIO

Night/Day wireless switch located in the parents' bedroom. Pressing the **top of the button** activates the scenario, which can be customised to suit users' needs in the Home + Control app.



- Switches on the lights in the kitchen and bathroom
- Switches on the standard lamp in the living room
- Opens the shutters in the bedrooms

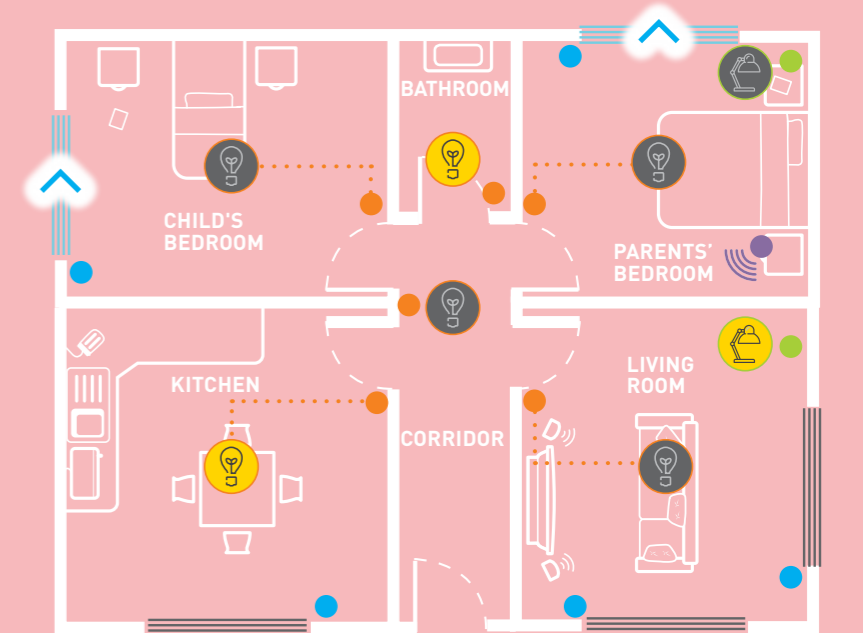

WIRING DIAGRAMS

GATEWAY 240V a.c.



The gateway must be installed close to the router where it can pick up a good Wi-Fi signal.

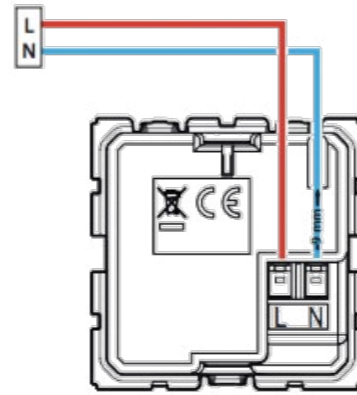

SMART SINGLE POWERPOINT 10A 240V a.c. 2400W max

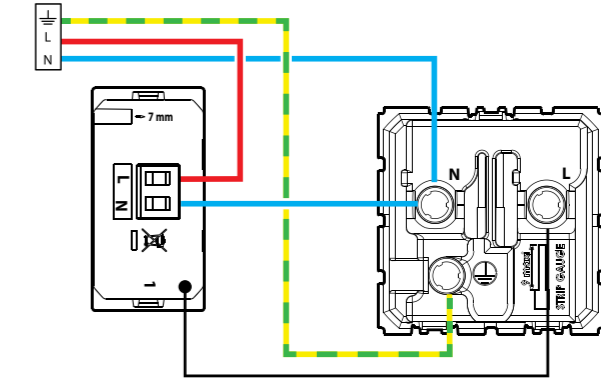
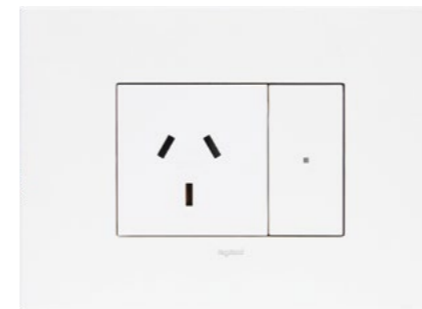

SMART LIGHT SWITCH 5W min, 300W max, with neutral

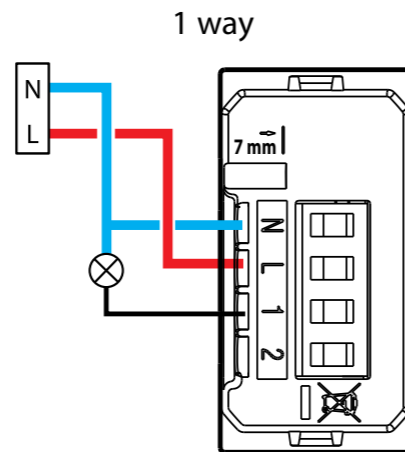

SMART SHUTTER/BLIND SWITCH 1 x 500VA - For all types of shutter motor with electronic or mechanical end stop

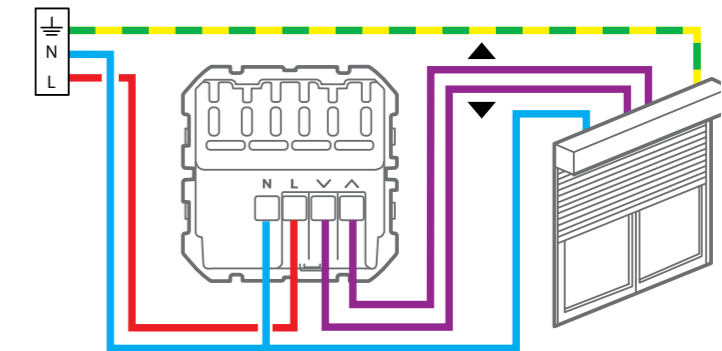

SMART DIMMER SWITCH 5W min, 300W max, without neutral

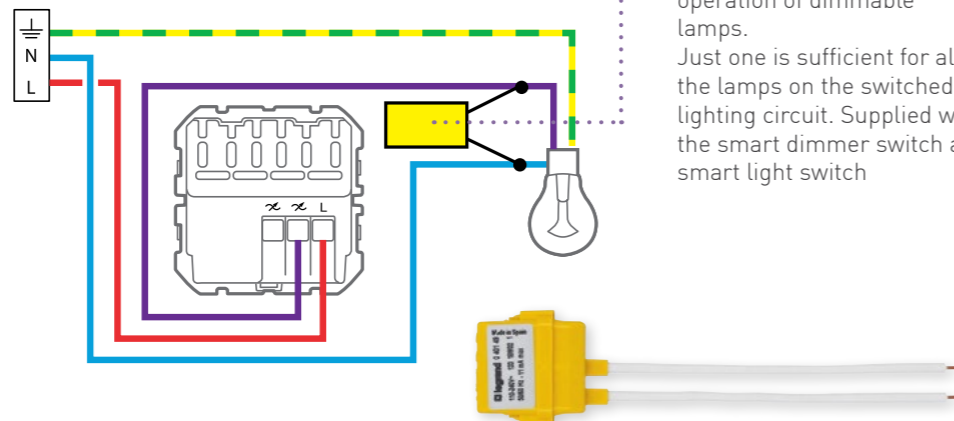
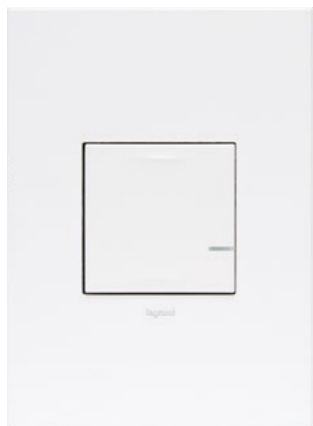

A load stabilising capacitor is important to ensure optimum operation of dimmable lamps. Just one is sufficient for all the lamps on the switched lighting circuit. Supplied with the smart dimmer switch and smart light switch

SMART LIGHTING MICROMODULE 240V a.c. - 300W max - All loads

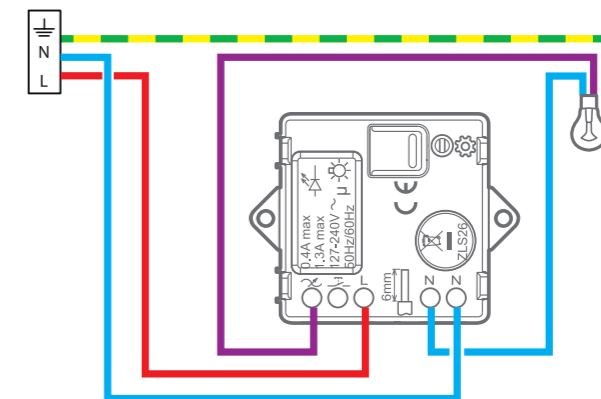

STARTING SETUP AND PAIRING

CREATE THE NETWORK

1 After installing and connecting up the wired products, **turn the power back on**. The LEDs on the products **light up with a steady red light**.

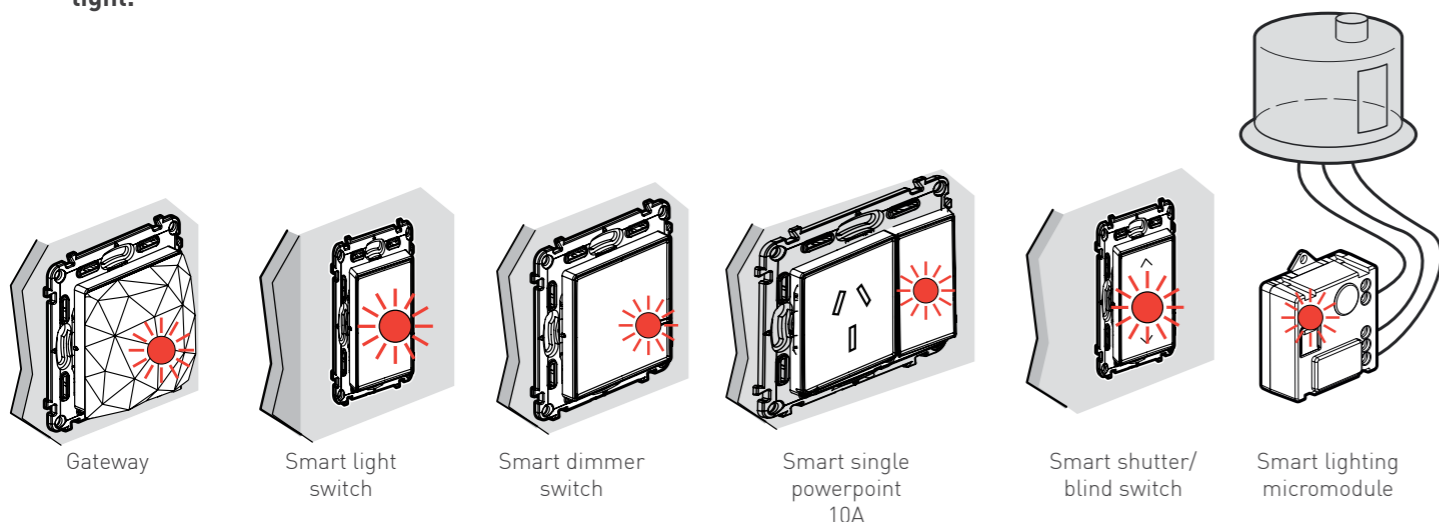

2 Remove the protective tab from the battery to supply power to the **wireless master switch**.

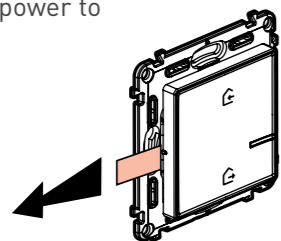

3 **Press briefly** in the centre of the wireless master switch in order to activate it. Its LED **flashes green** then **goes off**. The LED on the **Gateway power outlet** also goes off.

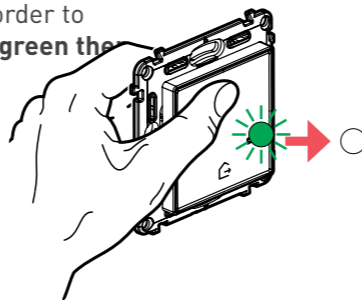

4 1-Move the wireless master switch close to the **Gateway** and **press the centre** of the switch until its LED briefly lights up green.
2-**Release hold**. The LED goes off.
3-The gateway power outlet LED changes to a steady green light.

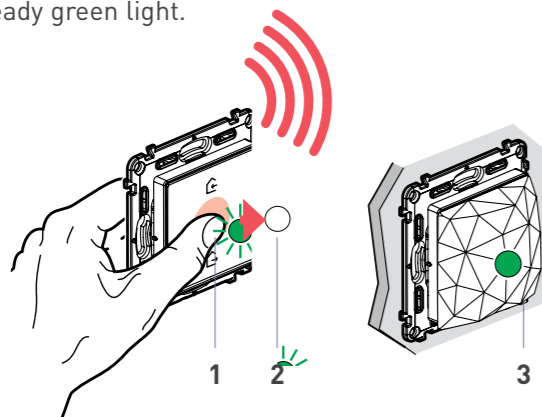

One after another, the LEDs on the other wired products change to a **steady green light**.

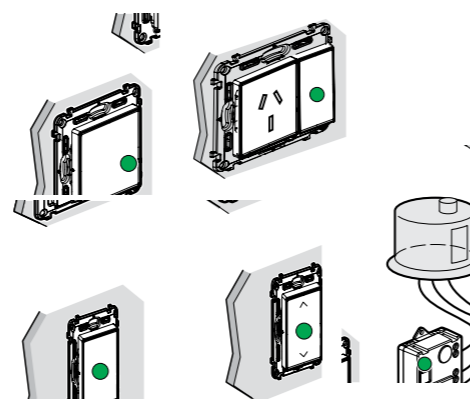

The network is created.

PAIR WIRELESS SWITCHES

1 After creating the network, you can pair wireless switches to control the connected switches and power points. **Remove the protection tab** from the wireless switch you wish to pair, **then go to steps 2, 3 and 4**. Repeat the same operation with each switch, one after another.

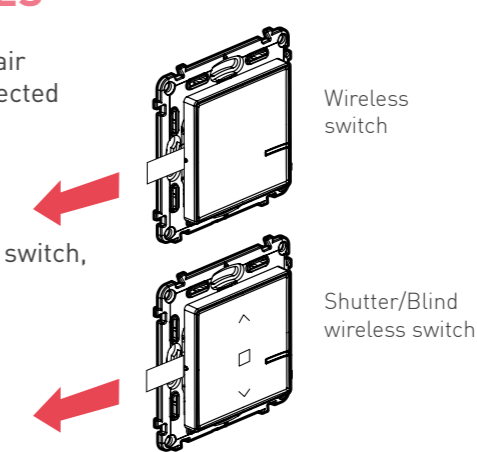

2 Press briefly.

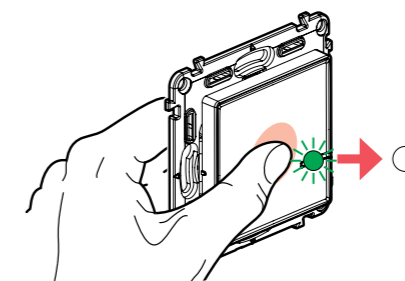

3 **Keep your finger pressed** on the top or bottom of the wireless switch, then **tap 3 times** on the product you wish to control.

4 1-The LEDs on both products **flash quickly** (blue) then light up **briefly** (steady blue).
2-The LED on the wireless switch **goes off**, the one on the wired product **reverts to green**.

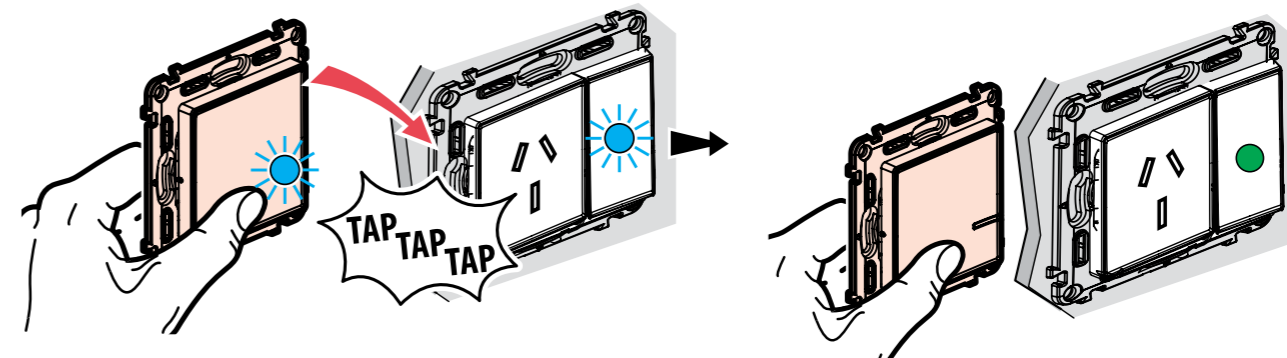

They have been paired successfully. Repeat the same operation with each wireless switch, one after another.

Possible combinations of wireless switches and wired products: see page 2

IMPORTANT: Once installation is completed, leave the starter kit user guide and product manuals with your customer. The user guide contains a unique code to configure the Apple HomeKit app.

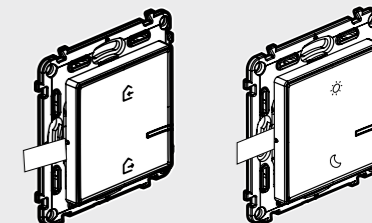

The **Wireless Master Switch** and **Night/Day wireless switches** are paired via the Home + Control app. For more information, please visit legrand.com or use the links below.

Wireless master switch:
<https://faq.homecontrol.eliotbylegrand.com/question/829>

Night/Day wireless switch:
<https://faq.homecontrol.eliotbylegrand.com/question/828>

HOME + CONTROL APP:

1 DOWNLOAD THE HOME + CONTROL APP

- Prerequisite: a working Wi-Fi router.
- Once you have downloaded the app, follow the step-by-step screens to create an account and set up your customer's installation.

If your customer is with you, and they have an iPhone: download the Home + Control app and set up the installation with their iPhone. This way, you will scan the Apple HomeKit single-use code directly into their iPhone (see next page).

IMPORTANT

If you are working alone: use an Android smartphone.

Do you only have an iPhone or iPad? Then avoid setting up the installation in the Home + Control app because your customer will not be able to scan the HomeKit code on their iPhone.

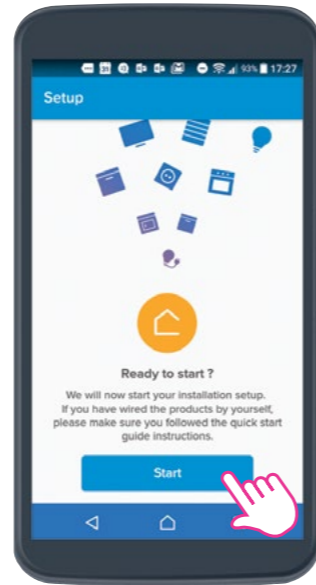
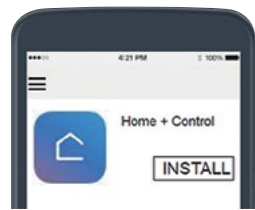

2 SET UP THE INSTALLATION (continued)

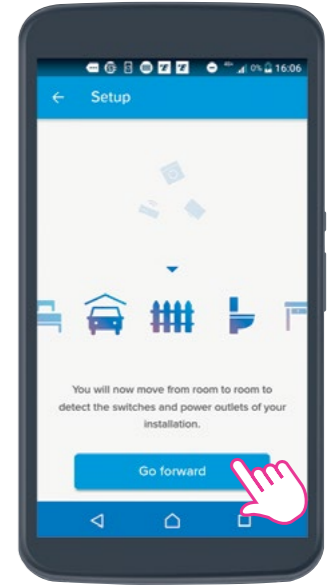
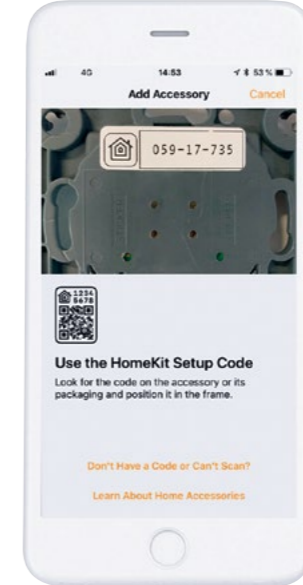
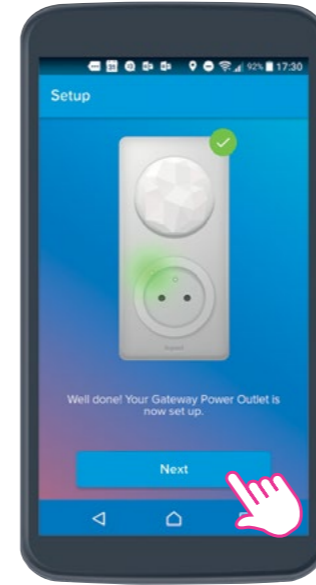

4-Click Next.

If you are using an iPhone: Set up the Apple Homekit before going to step 5.

With the iPhone: scan the code on the gateway or on the back of the user manual.

5-Click Go forward and move from room to room: the app will automatically detect any installed wired products.

2 SET UP THE INSTALLATION

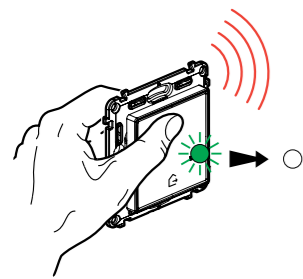

First, hold down the centre of the Wireless master switch until it briefly lights up green.

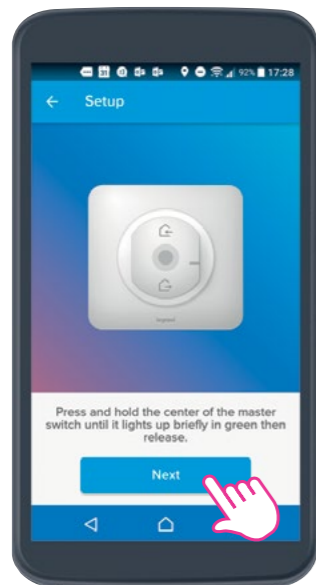

1-Click Next.

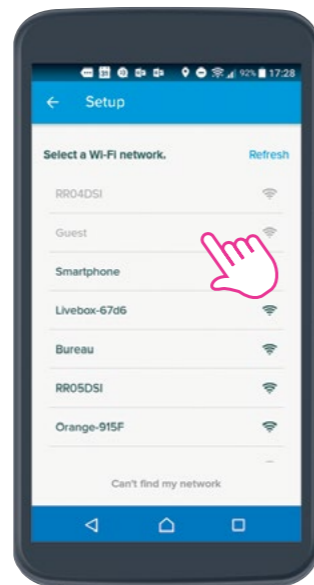

2-Select the house or router Wi-Fi network to connect the gateway power outlet to it.

If you are using an Android smartphone: enter the router password



3-The gateway connects to the Wi-Fi automatically.

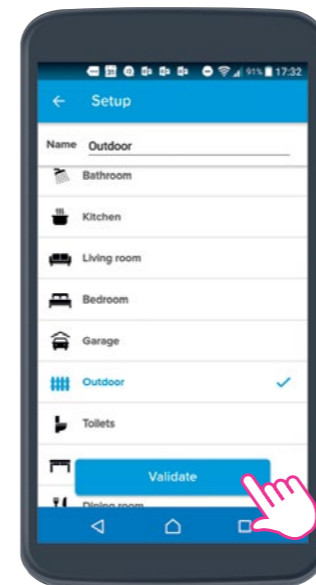

6-Select the type of room you are in and click Validate.

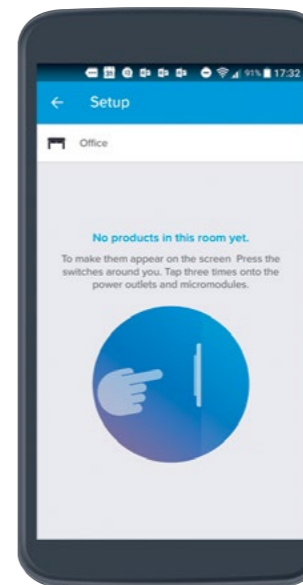

7-Press the switch or tap three times on the connected power outlets and micromodules installed in the room.

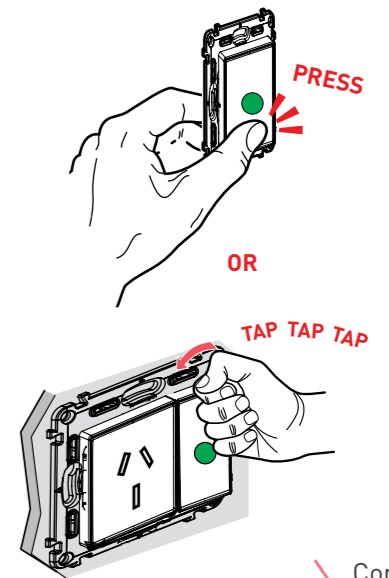

Continued on page 18

HOME + CONTROL APP:

2 SET UP THE INSTALLATION (continued)

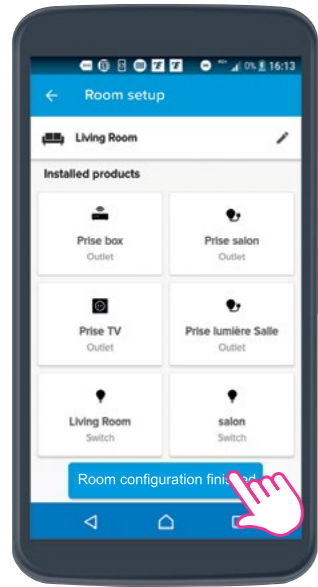

8-Click **Room configuration finished** once all the products have been detected.

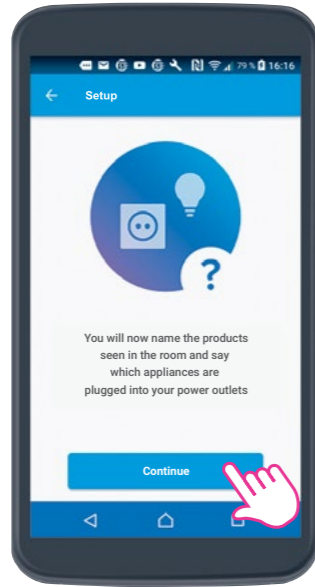

9-Click **Continue** to name products.

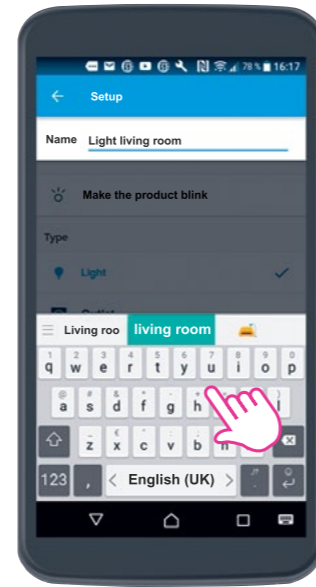

10-Name the products.

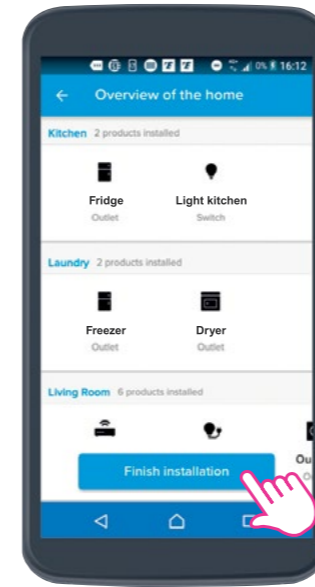

14-Click **Finish installation** once you have completed all rooms.

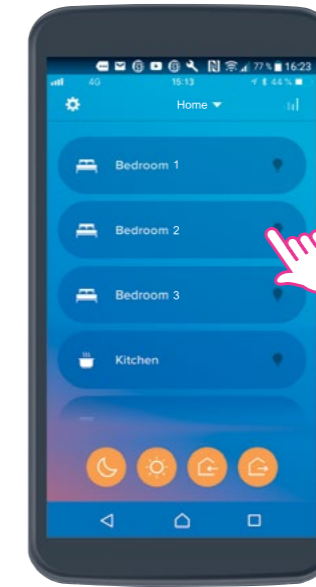

15-You will now be able to find all rooms and control the lights electrical appliances and shutters/blinds.

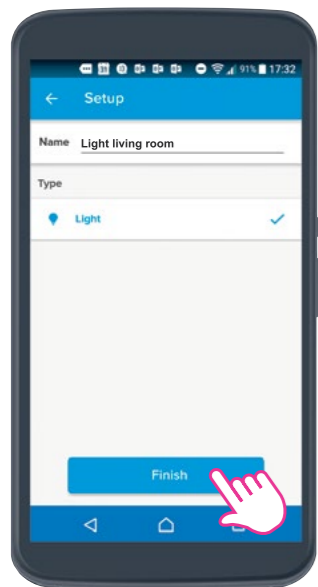
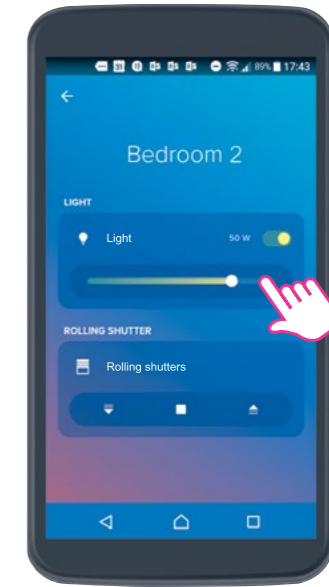

11-Once all products are named. Click **Finish**.

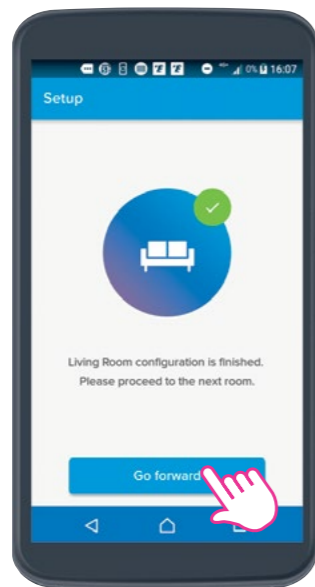

12-Click **Go forward** and move to the next room.

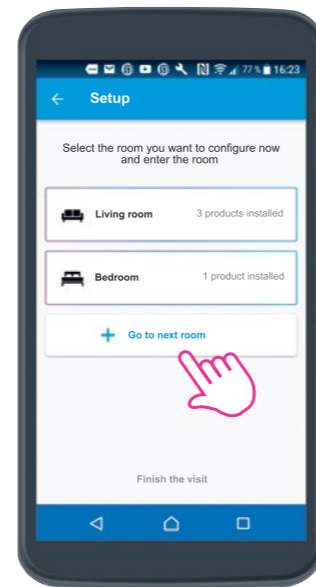

13-Click **Go to next room** and enter the room. Repeat **steps 8 to 14**.

3 CHANGE THE LOCATION OF PRODUCTS ROOM BY ROOM

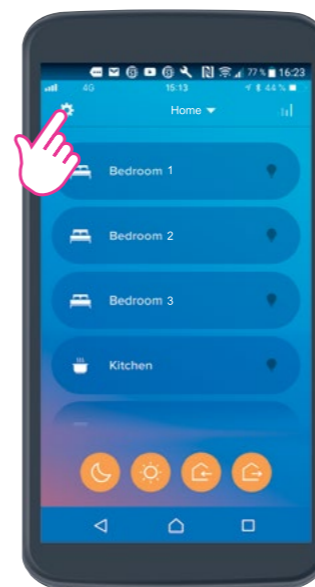

1-Click **Settings**.

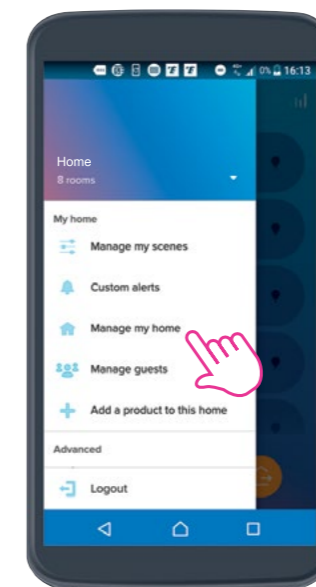

2-Select **Manage my home**.

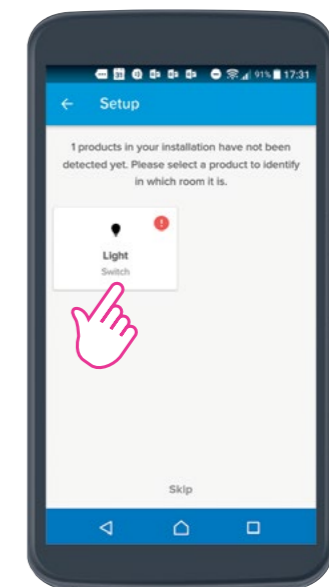

3-Select for example **Light**.

Continued on page 20

HOME + CONTROL APP:

3 CHANGE THE LOCATION OF PRODUCTS ROOM BY ROOM (continued)

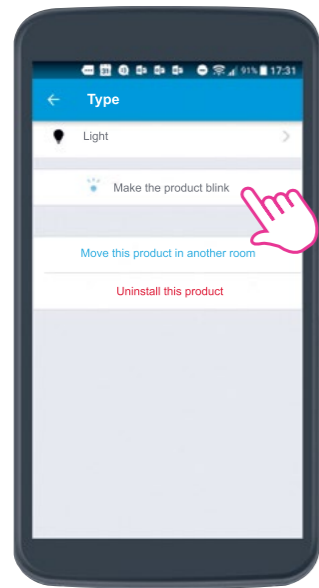

4-You can make the **Light** product blink so you can physically identify it.

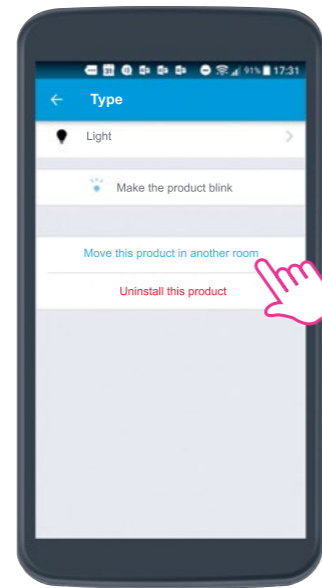

5-Click here to assign the **Light** product to a room.

4 MAKE THE INSTALLATION AVAILABLE TO YOUR CUSTOMER AND DELETE YOUR ACCESS DETAILS

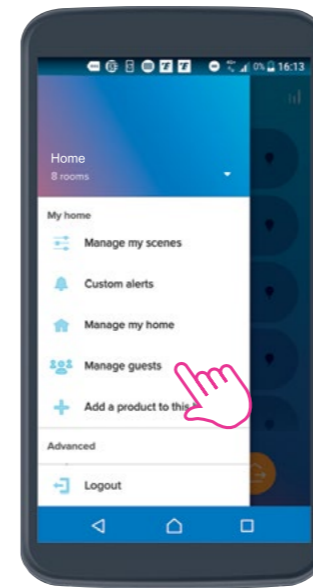

1-Click **Manage guests** and follow the step-by-step instructions.

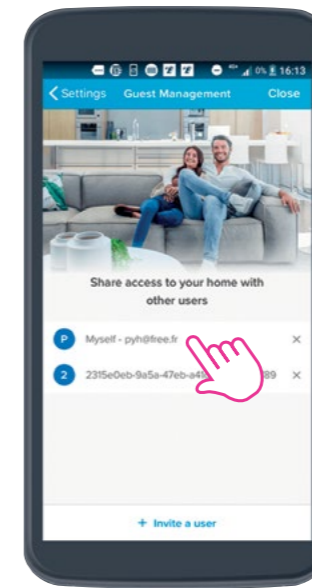

2-Select **your own access details**.

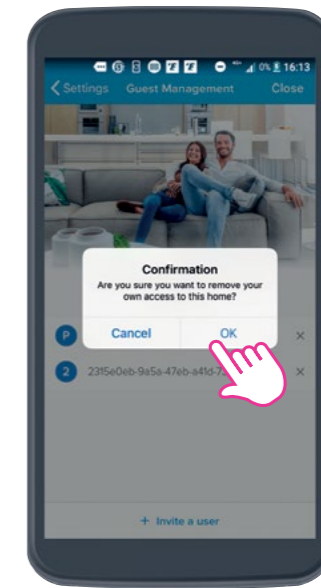

3-Remove them from the list.

The installation setup is still available and will appear in your customer's Home + Control app when they download it.

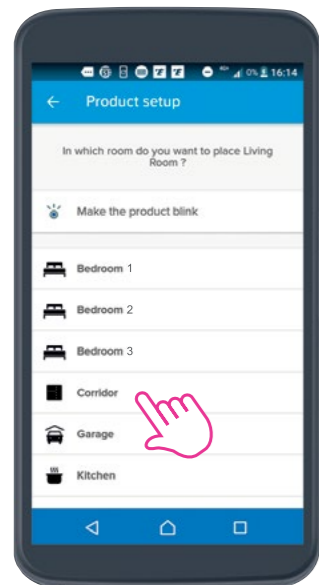

6-Position the Light product for example in the **Corridor**.

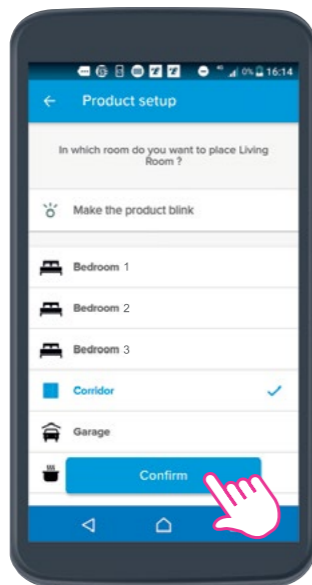

7-Click **Confirm** to confirm.

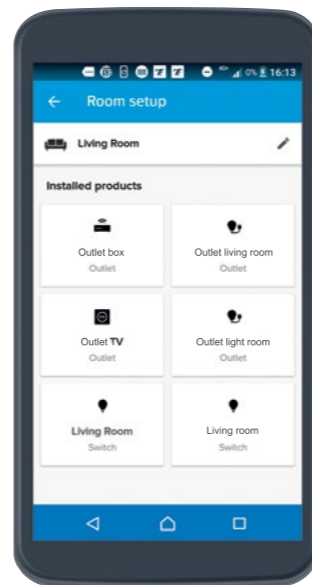

Continue in the same way to allocate each product to a room. Example: the **Appliance** and **Light micromodule** products have been assigned to the **Living room**.
NB: You can rename rooms and appliances using the same procedure if you wish.

SHARE THE HOME + CONTROL APP BETWEEN SEVERAL USERS

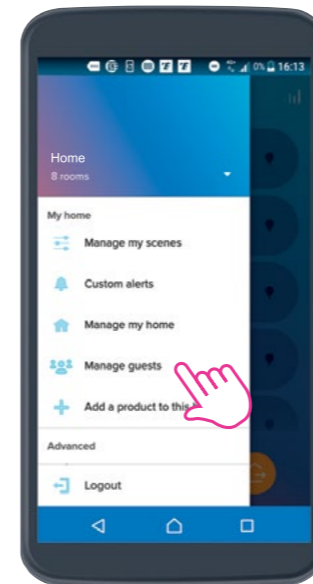

1-Click **Manage guests**.

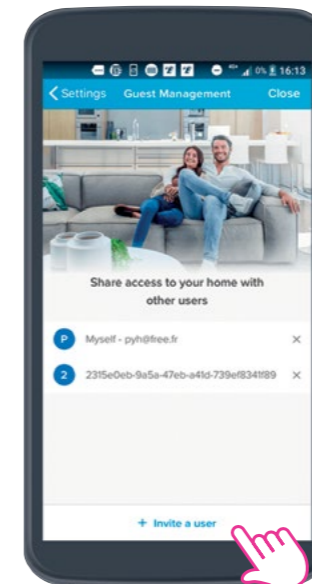

2-Click **Share access to your home with other users** and follow the step-by-step instructions.

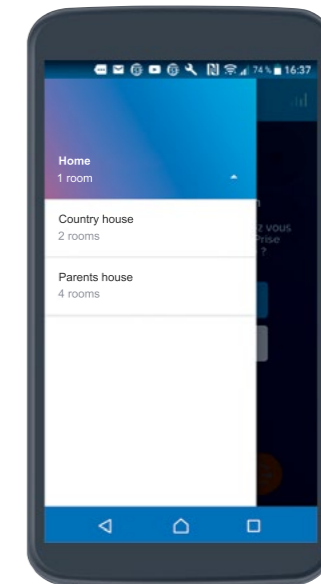

Go to the list of homes⁽¹⁾ and click on the home you wish to control

(1) **Android:** settings, at the top of the screen
iPhone: in the centre, at the top of the home screen

Connected home

Starter Kit

Must be ordered for any connected installation

Step 1: Starter kit for a connected home



AWNKITWE

Used to control your home remotely (lighting and electrical appliances) using a smartphone via the Home + Control App and/or voice control (via a voice assistant). Must be ordered for any connected installation. The connected extension kit or individual connected products can be added to the starter kit. 2.4 GHz Wi-Fi connection required.

Pack	Cat.Nos	Starter Kit
1	AWNKITWE	Used to create a connected installation. Includes: - 1 Gateway 240V a.c. Wi-Fi 2.4GHz 802.11 b/g/n Zigbee 2.4GHz to 2.4835GHz Supplied with support frame, coverplate and paint cover - 1 Vertical Smart switch 1 gang 240V a.c. 3 wire min. load 5W Max. load 300W. Compatible with most traditional and LED Lighting loads Zigbee 2.4GHz to 2.4835GHz Supplied with load stabilising capacitor, support frame, coverplate and paint cover - 1 Smart Single Powerpoint (protected against overloads) 240V a.c. 10A Compatible with any electrical appliance or large Household appliance. Measures instantaneous Power and monitors daily and monthly consumption, Plus sends configurable notifications (fault, consumption, etc) Supplied with support frame, coverplate and paint cover. Zigbee 2.4GHz to 2.4835GHz - 1 Wireless master switch with preset scenarios which can be customised in the Home + Control App. Supplied with CR2032 3V battery for power supply and 4 removable stickers for fixing the control on any walls. LED function for low battery indication Supplied with support frame and coverplate Zigbee 2.4GHz to 2.4835GHz
1	AWNKITMGN	White
1	AWNKITALU	Magnesium
1	AWNKITCHP	Aluminium
1	AWNKITMGN	Champagne

Pack	Cat.Nos	Basic Kit
1	AWNBKITWE	Used to create a connected installation, includes: - 1 Gateway 240V a.c. Wi-Fi 2.4GHz 802.11 b/g/n Zigbee 2.4GHz to 2.4835GHz Supplied with support frame, coverplate and paint cover - 1 Wireless master switch with preset scenarios which can be customised in the Home + Control app. Supplied with CR2032 3V battery for power supply and 4 removable stickers for fixing the control on any walls. LED function for low battery indication. Supplied with support frame and coverplate Zigbee 2.4GHz to 2.4835GHz
1	AWNBKITMGN	White
1	AWNBKITALU	Magnesium
1	AWNBKITCHP	Aluminium
1	AWNBKITMGN	Champagne

Connected home

Extension Kit

Step 2: Connected extension kit



AWNEKITWE

Used to complete your connected installation, requires prior installation of a starter or basic kit. Connected products can be added to the extension kit.

Pack	Cat.Nos	Extension Kit
1	AWNEKITWE	Used to create a wireless two-way switch and remotely control your electrical appliances. Includes: - 1 Smart Single Powerpoint 240V a.c. 10A (Protected against overloads). Compatible with any electrical appliance or large household appliance. Measures instantaneous power and monitors daily and monthly consumption, plus sends configurable notifications (fault, consumptions, etc). Zigbee 2.4GHz to 2.4835GHz Supplied with support frame, coverplate and paint cover - 1 wireless switch. Supplied with CR2032 3V battery for power supply and 4 removable stickers for fixing the control on any walls. Zigbee 2.4GHz to 2.4835GHz - 1 Vertical Smart Dimmer Switch 1 Gang 240V a.c. 2 wire (no neutral) Min. load 5W Max. load 300W Compatible with most traditional and LED lighting loads. Supplied with load stabilising capacitor Zigbee 2.4GHz to 2.4835GHz Dimmer mode can be activated in the Home + Control app. Locator LED light at the front can be activated in the Home + Control app. Supplied with support frame, coverplate and paint cover
1	AWNEKITMGN	White
1	AWNEKITALU	Magnesium
1	AWNEKITCHP	Aluminium
1	AWNEKITMGN	Champagne

Connected home

Connected Products

Step 2: Connected products

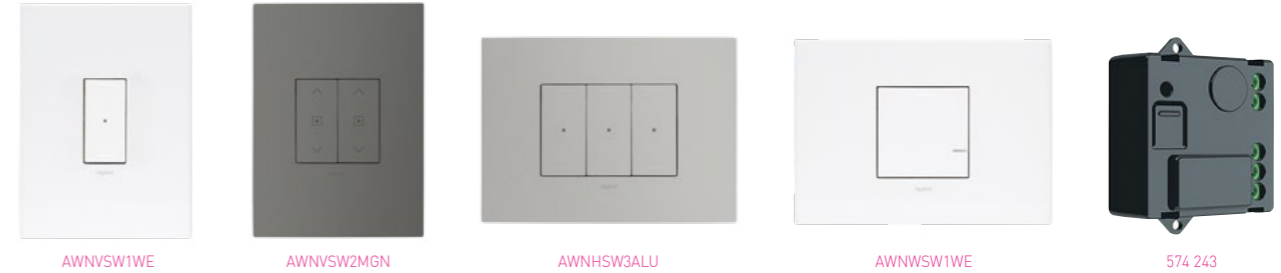

AWNWSW1WE

AWNWSW2MGN

AWNHSW3ALU

AWNWSW1WE

574 243

Used to complete your connected installation, requires prior installation of a Starter kit for connected installation.

Pack	Cat.Nos	Smart Light Switch
1	AWNNSW1WE	240V a.c. 3 wire Min. load 5W Max. load 300W Compatible with most traditional and LED Lighting loads Zigbee 2.4GHz to 2.4835GHz Supplied with load stabilising capacitor, support frame, coverplate and paint cover
1	AWNNSW1MGN	Vertical - 1 Gang
1	AWNNSW1ALU	White
1	AWNNSW1CHP	Magnesium
1	AWNNSW2WE	Vertical - 2 Gang
1	AWNNSW2MGN	White
1	AWNNSW2ALU	Magnesium
1	AWNNSW2CHP	Aluminium
1	AWNNSW1WE	Horizontal - 1 Gang
1	AWNNSW1MGN	White
1	AWNNSW1ALU	Magnesium
1	AWNNSW1CHP	Aluminium
1	AWNNSW2WE	Horizontal - 2 Gang
1	AWNNSW2MGN	White
1	AWNNSW2ALU	Magnesium
1	AWNNSW2CHP	Aluminium
1	AWNNSW3WE	Horizontal - 3 Gang
1	AWNNSW3MGN	White
1	AWNNSW3ALU	Magnesium
1	AWNNSW3CHP	Aluminium
1	AWNNSW3CHP	Champagne

Pack	Cat.Nos	Smart Dimmer Switch
1	AWNNDM1WE	240V a.c. 2 wire (no neutral) Min. load 5W Max. load 300W Compatible with most traditional and LED lighting loads. Supplied with load stabilising capacitor Zigbee 2.4GHz to 2.4835GHz Dimmer mode can be activated in the Home + Control app. Locator LED light at the front can be activated in the Home + Control app. Supplied with support frame, coverplate and paint cover
1	AWNNDM1MGN	Vertical - 1 Gang
1	AWNNDM1ALU	White
1	AWNNDM1CHP	Magnesium
1	AWNNDM1MGN	Aluminium
1	AWNNDM1ALU	Champagne
1	AWNNDM1CHP	Horizontal - 1 Gang
1	AWNNDM1WE	White
1	AWNNDM1MGN	Magnesium
1	AWNNDM1ALU	Aluminium
1	AWNNDM1CHP	Champagne
1	AWNNSW1WE	Wireless Switch
1	AWNNSW1MGN	Supplied with CR2032 3V battery and 4 stickers to mount on walls. Zigbee 2.4GHz to 2.4835GHz Supplied complete with support frame and coverplate
1	AWNNSW1ALU	White
1	AWNNSW1CHP	Magnesium
1	AWNNSW1MGN	Aluminium
1	AWNNSW1CHP	Champagne

Pack	Cat.Nos	Connected lighting micromodule
1	574 243	Used to provide connected lighting 300W, with neutral Can be controlled by home + control app push-button switch or wireless switches - paired by tapping the wireless control on the micromodule For installation close to the lighting load Zigbee 2.4GHz to 2.4835GHz

Step 2: Connected products



Used to complete your connected installation, requires prior installation of a Starter or Basic kit

Pack	Cat.Nos	Smart Single Powerpoint
1	AWNHGPOWE	<p>Used to control electrical appliances remotely Can be paired with one or more wireless switch to create a controlled socket 10A 240V a.c. Compatible with any electrical appliance or large household appliance Measures instantaneous power and monitors daily and monthly consumption, plus sends configurable notifications (fault, consumption, etc) Supplied with support frame, coverplate and paint cover Zigbee 2.4GHz to 2.4835GHz</p>
1	AWNHGPOMGN	
1	AWNHGPOALU	
1	AWNHGPOCHP	

Pack	Cat.Nos	Connected roller shutter switch
1	AWNVBLIWE	<p>For local and remote control of a 240V a.c. shutter/blind (raise/lower/stop functions, compatible with shutter/blind with mechanical and electronic stop, not compatible with radio-controlled shutter/blind) Can be paired with one or more shutter/blind wireless switches. Can be installed in place of an existing shutter/blind switch Supplied with support frame, coverplate and paint cover Zigbee 2.4GHz to 2.4835GHz</p>
1	AWNVBLIMGN	
1	AWNVBLIALU	
1	AWNVBLICHP	

Pack	Cat.Nos	Wireless shutter/blind switch
1	AWNWBLIWE	<p>Used to control one or more wired shutter/blind switches Pair by tapping on the selected shutter/blind switch(es) Supplied with CR2032 3 V battery for power supply and 4 removable stickers for fixing the control unit on any walls LED function for low battery indication Zigbee 2.4GHz to 2.4835GHz</p>
1	AWNWBLIMGN	
1	AWNWBLIALU	
1	AWNWBLICHP	

Step 2: Connected products

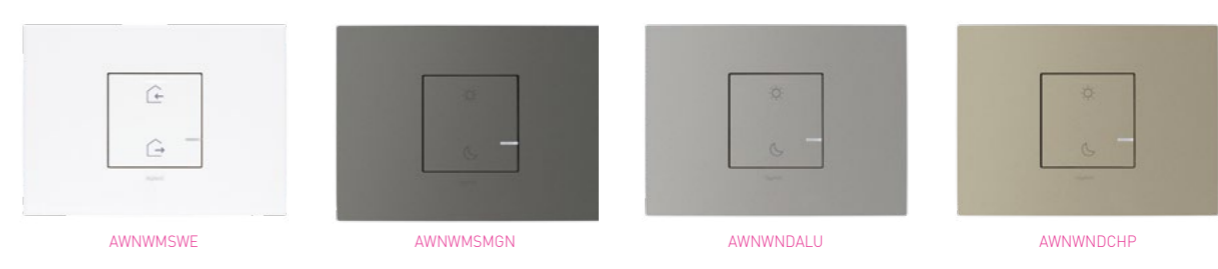

Used to complete your connected installation, require prior installation of a starter kit for connected installation

Pack	Cat.Nos	Wireless master switch
1	AWNWMSWE	<p>Used to add an extra Wireless master switch in a connected installation with multiple entrances Works in the same way as the Wireless master switch included in the starter kit or basic kit Home/Away scenarios can be customised in the Home + Control App Supplied with CR2032 3 V battery for power supply and 4 removable stickers for fixing the control unit on any walls LED function for low battery indication Supplied with support frame, and coverplate paint cover Zigbee 2.4GHz to 2.4835GHz</p>
1	AWNWMSMGN	
1	AWNWMSALU	
1	AWNWMSCHP	

Pack	Cat.Nos	Night/Day Wireless switch
1	AWNWNDWE	<p>Used to add 2 extra scenarios to a connected installation Preset Wake up/Sleep scenarios which can be customised in the Home + Control App Supplied with CR2032 3 V battery for power supply and 4 removable stickers for fixing the control unit on any walls. LED function for low battery indication Supplied with support frame, and coverplate. Zigbee 2.4GHz to 2.4835GHz</p>
1	AWNWNDMGN	
1	AWNWNDALU	
1	AWNWNDCHP	

NOTES

Lined area for notes on page 24, consisting of multiple horizontal dashed lines.

NOTES

Lined area for notes on page 25, consisting of multiple horizontal dashed lines.

NOTES

Lined area for taking notes.

COMPATIBILITY

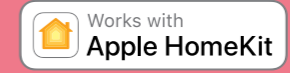

VOICE ASSISTANTS

Arteor with Netatmo is compatible with the main voice assistants.



NETATMO



AN OPEN SYSTEM

Arteor with Netatmo is an open system for everyone in the connected home.



Legrand Australia

Building 4, Nexus Industry Park
43-47 Lyn Parade
Prestons NSW 2170
Tel.: 1300 369 777
www.legrand.com.au

Legrand New Zealand

106 - 124 Target Road
Glenfield
Auckland 0627
Tel.: 0800 476 009
www.legrand.co.nz